



The Heart of Industry

IWAKI

IWAKI
MAGNETIC
DRIVE
PUMPS

MXM



Solutions for chemical handling applications



Better withstanding difficult operating conditions

The proven non-contact system and self-radiating bearing structure deliver substantial improvements in tolerance of dry running and poor suction conditions.

Non contact system

Unlike conventional magnetic drive pumps, the MXM series are designed to prevent contact between the bearing and the rear thrust faces, even during dry running. By preventing contact, the rear thrust ring minimizes heat generation to prevent melting of plastic parts.

Self radiation structure

Through heat-dispersion holes provided in the fixed portions of the impeller and the magnet capsule, the liquid around the spindle and the bearing is forced to circulate so that heat generated by sliding can be reduced effectively. Thus, thermal deformation and melt are prevented.

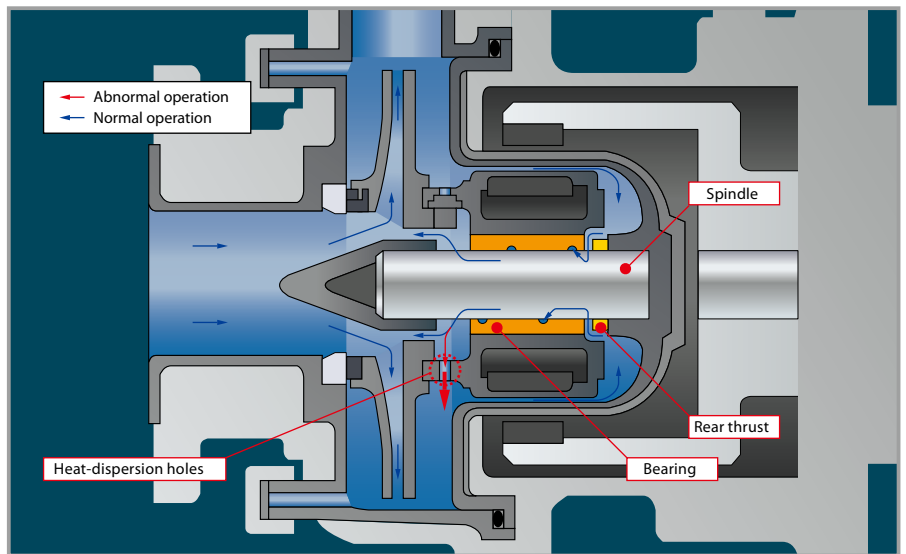

MXM545

MXM542

Magnetic drive pumps with an excellent balance of features and performance

The MXM series of pumps have now been added to the line-up of Iwaki's magnetic drive process pumps, which have earned high acclaim and the trust of users all around the world. The new MXM series feature an excellent balance of the characteristics required of chemical pumps, including corrosion resistance, durability and safety. They employ a non-contact, self-radiating bearing structure to better withstand difficult operating conditions. The advent of the MXM series has further expanded the array of choices offered by Iwaki's process magnetic drive pumps.

Exceptional corrosion resistance

The MXM series employ optimum anti-corrosive materials such as carbon fiber reinforced ETFE (CFRETFE), high quality ceramic and carbon for parts that come in contact with liquid. The most suitable impeller size and motor output can be selected for the required liquid property.



Impeller+Magnet capsule



Spindle+Bearing

Robust structure

The pumps have an external armour of high strength ductile cast iron for use in heavy duty chemical process applications. The sealing performance between the front casing and the rear casing is drastically enhanced by our original structure, offering high reliability.



Cover+Front casing

Enhanced safety

The MXM features a unique rear casing shape designed to prevent stress concentration. This increases both the pump's pressure resistance and the mechanical strength of the spindle support. The high temperature model uses a dual structure incorporating an FRP rear casing cover. In addition to further increasing the pump's pressure resistance, it improves safety with dual containment preventing liquid leakage in the event of unexpected damage to the rear casing.



Rear casing+Rear casing cover (Option)



MXM44

MXM22



Construction and materials

Part	Material code	CF	FF	KK
1 Front casing	CFRETFE			
2 Rear casing				
3 Impeller				
4 Magnet capsule				
5 Spindle	High-purity alumina ceramic			SiC
6 Bearing	High-density carbon	High-purity alumina ceramic		
7 Liner ring	High-purity alumina ceramic			
8 Mouth ring	PTFE with filler			
9 Rear thrust		CFRETFE		
10 O ring		FKM/EPDM/AFLAS®/ DAI-EL PERFLUORO®		
11 Lock pin	Note	CFRETFE		

Note: 54 type only

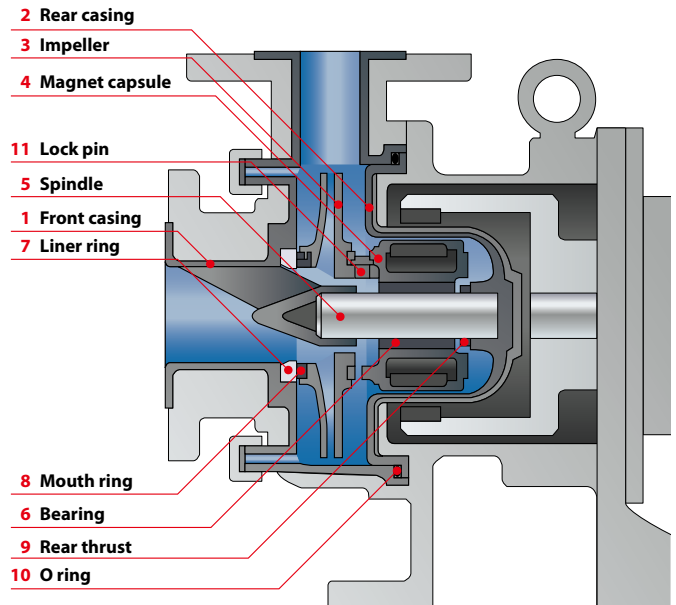

Specifications

Model	Pump size Suction × Discharge	50Hz			60Hz		
		Impeller size	Capacity L/min	Head m	Impeller size	Capacity L/min	Head m
MXM22 (Impeller range 1)	25mm × 25mm	100	150	7.5	080	150	6.5
		090	150	5.5	070	150	5
		070	150	2.5	–	–	–
MXM22 (Impeller range 2)	25mm × 25mm	105	150	8	105	150	14
		–	–	–	090	50	12
MXM44 (Impeller range 1)	40mm × 40mm	115	200	9.5	120	200	17
		110	200	8	105	200	11
		100	200	6	095	200	9.5
		090	200	5	085	200	7.5
		–	–	–	075	200	5
MXM44 (Impeller range 2)	40mm × 40mm	130	200	12	130	100	25
MXM54 (Impeller range 1)	50mm × 40mm	150	200	18.5	150	200	30.5
		140	200	17	140	200	27.5
		120	200	13.5	–	–	–
MXM54 (Impeller range 2)	50mm × 40mm	–	–	–	130	200	21.5
		–	–	–	120	200	19
		–	–	–	110	200	15
MXM54 (Impeller range 3)	50mm × 40mm	150	300	20	130	300	26
		140	300	18.5	120	300	20.5
		130	300	16.5	–	–	–
		110	300	10.5	–	–	–
MXM54 (Impeller range 4)	50mm × 40mm	150	400	25	150	200	41
		140	400	20.5	140	400	29.5
		125	400	15.5	130	400	25
		110	400	9.5	120	400	21.5

Note1: Liquid temp. range

Standard: -10 to 90 °C High temp. version (with rear casing cover): -10 to 105 °C (10 to 105 °C when AFLAS® O ring is used)

Note2: Max operating pressure

Standard MXM22: 0.2MPa, MXM44: 0.3MPa, MXM54: 0.45MPa High temp. version (with rear casing cover): 0.7MPa

Pump identification

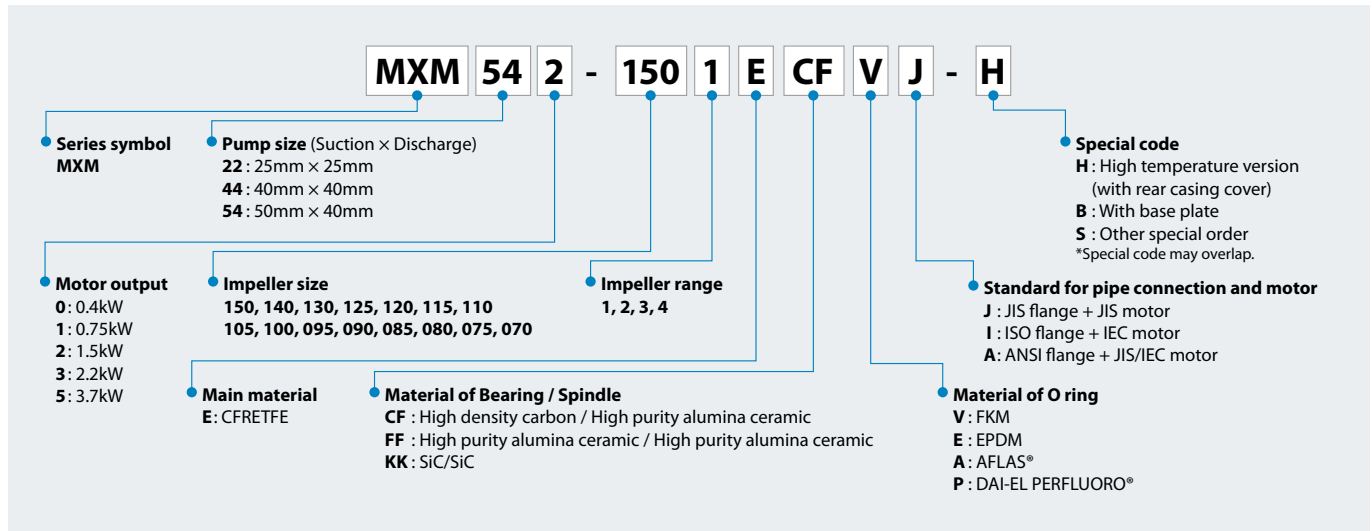

Notes for selection

(1) The performance curves in this catalogue represent the data measured using clear water at 20 °C.

(2) Choose the pump model suited to the liquid gravity.

Make sure that the motor output is ten percent higher than theoretically required.

$$\text{Shaft power (Sp)} \times \text{liquid gravity} \times 1.1 < \text{Motor output}$$

(Note) The shaft power (Sp) increases in proportion to the liquid gravity.

As the viscosity rises, the shaft power is higher while the head and the discharge are lower.
The power and the performance need to be adjusted.

(3) No magnetic drive pump supports continuous closed running. Be sure to ensure the minimum flow volume.

- Minimum flow volume
 - MXM22/44 : 10 L/min.
 - MXM54 Impeller range 1, 2 and 3 : 20 L/min.
 - Impeller range 4 : 50 L/min.

(4) The pressure resistance of the pump is as follows.

Be sure to ensure that the internal pressure of the pump does not exceed the value specified below.

- Standard model -10 °C to 90 °C (without rear casing cover)
 - MXM22: 0.2MPa, MXM44: 0.3MPa, MXM54: 0.45MPa
- High temperature version -10 °C to 105 °C (with rear casing cover)
 - : 0.7MPa

(5) FF material models

- Liquid should be 1m Pa-s (cP) or more.
- HQ performance is somewhat different from CF/KK models. If you need to know the detail, please contact with us.

(6) Deliberate prolonged dry running or entrained air operation is not recommended.

- The CF type has a degree of tolerance to dry running and operation with entrained air in the liquid.
- The KK type has the same degree of tolerance as the CF type under operation with entrained air in the liquid, but not allowed to run dry.
- The FF type is not allowed to run dry or operation with entrained air.

Performance curves

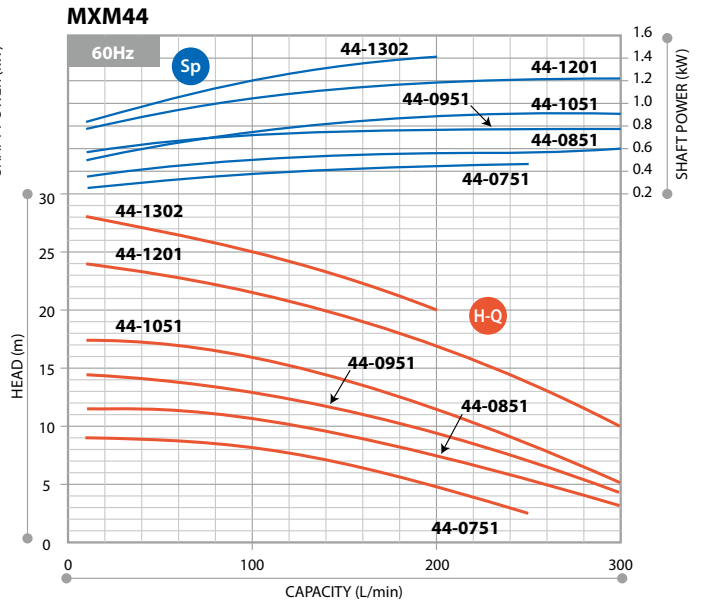
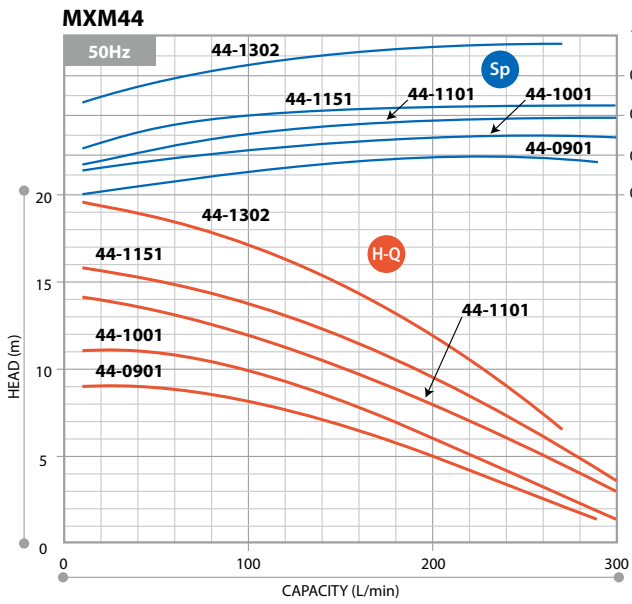
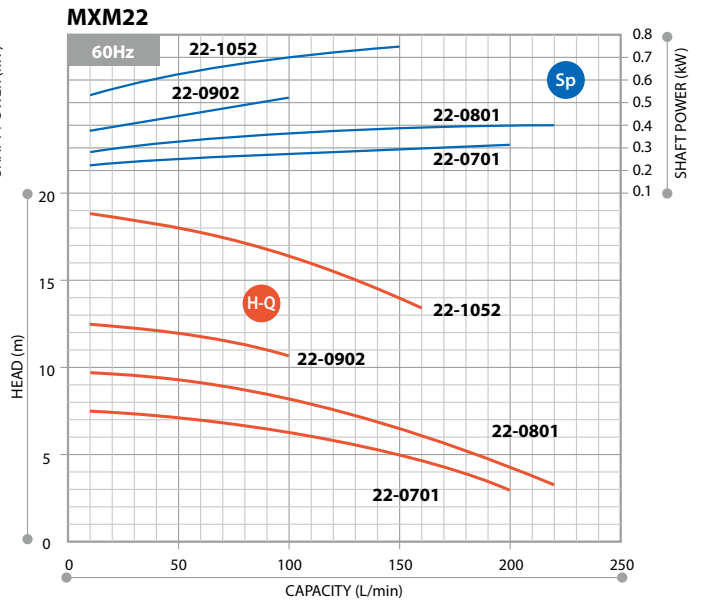
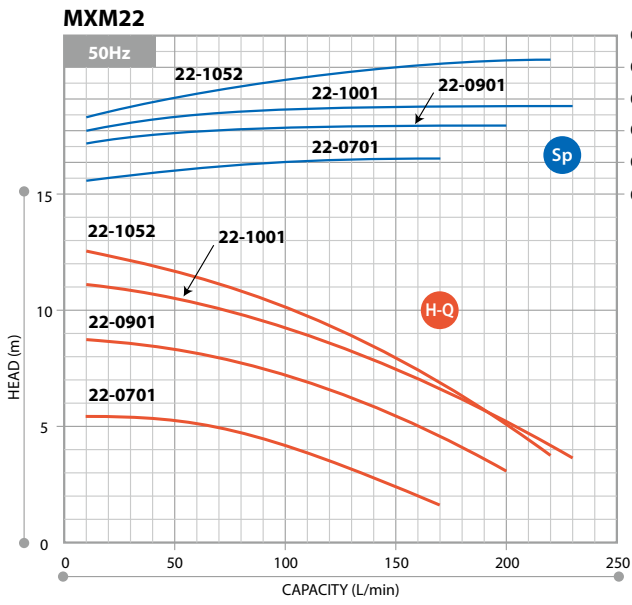

The shaft power curves shown above are calculated by using our standard test motor. Contact us for detail.



MXM54 (Impeller range 1)

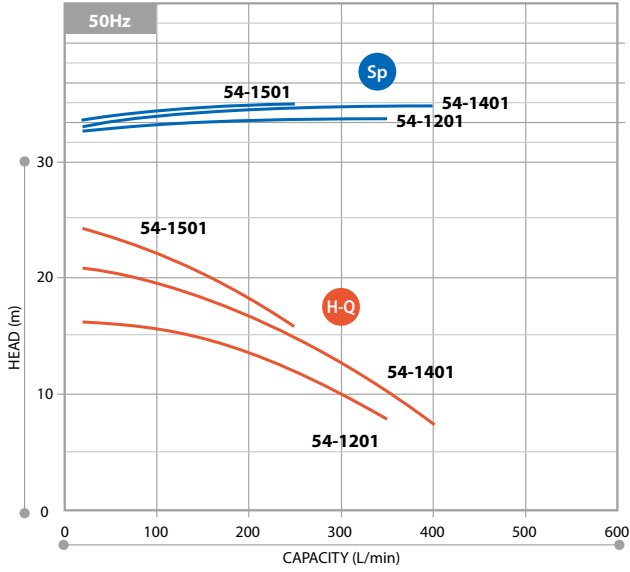

MXM54 (Impeller range 1, 2)

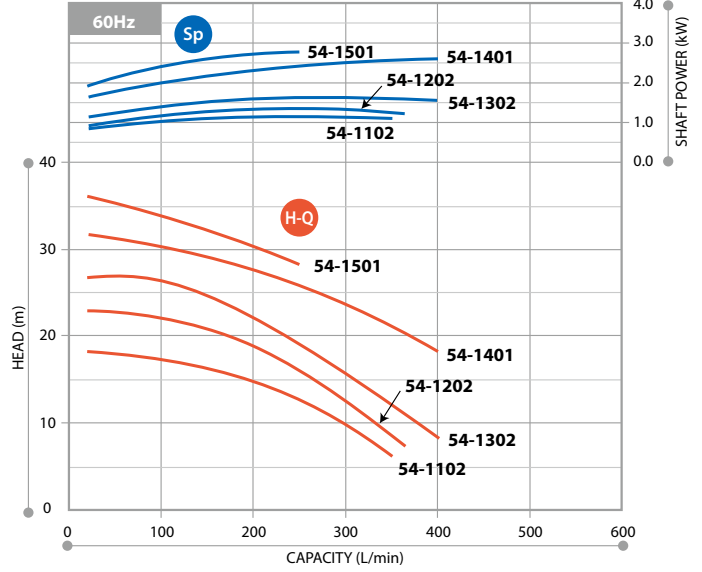

MXM54 (Impeller range 3)

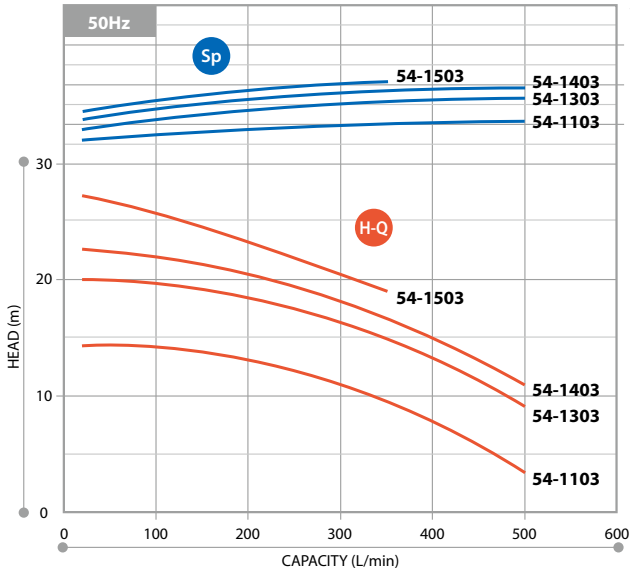

MXM54 (Impeller range 3)

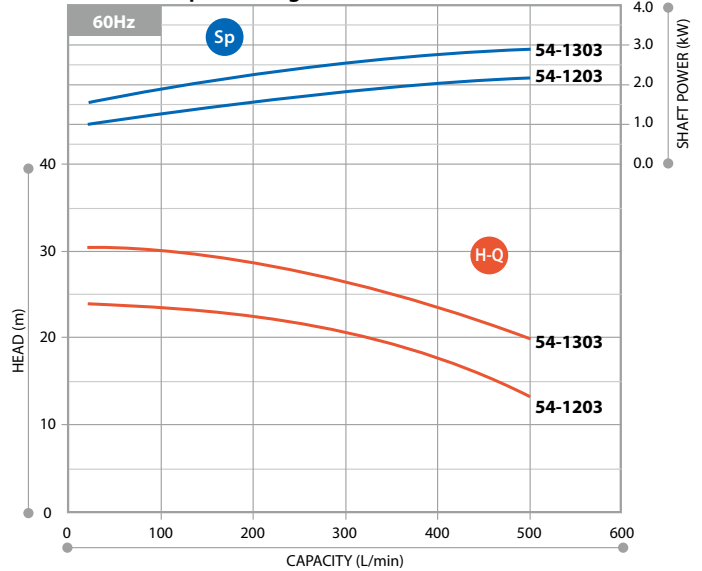

MXM54 (Impeller range 4)

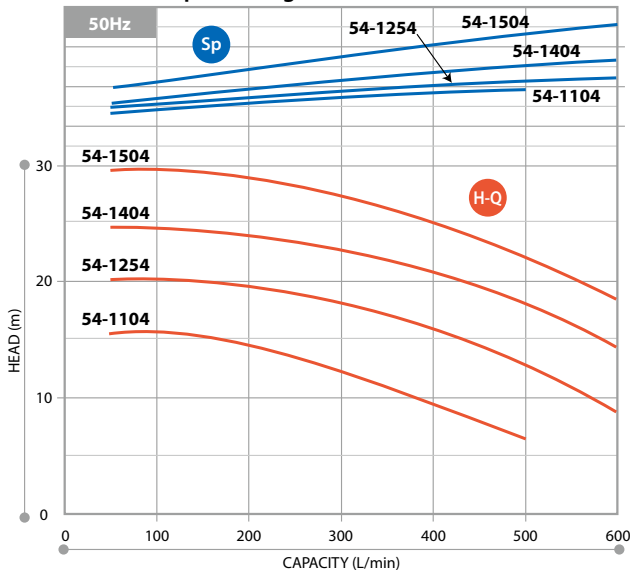

MXM54 (Impeller range 4)

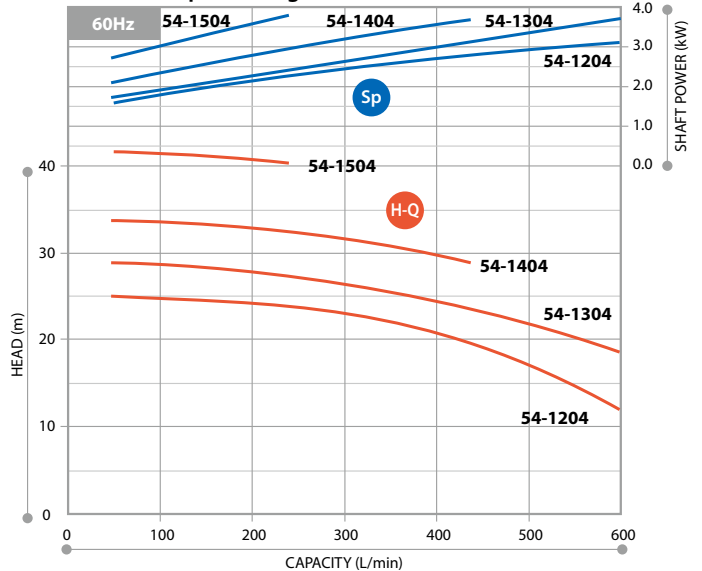

The shaft power curves shown above are calculated by using our standard test motor. Contact us for detail.

Dimensions in mm

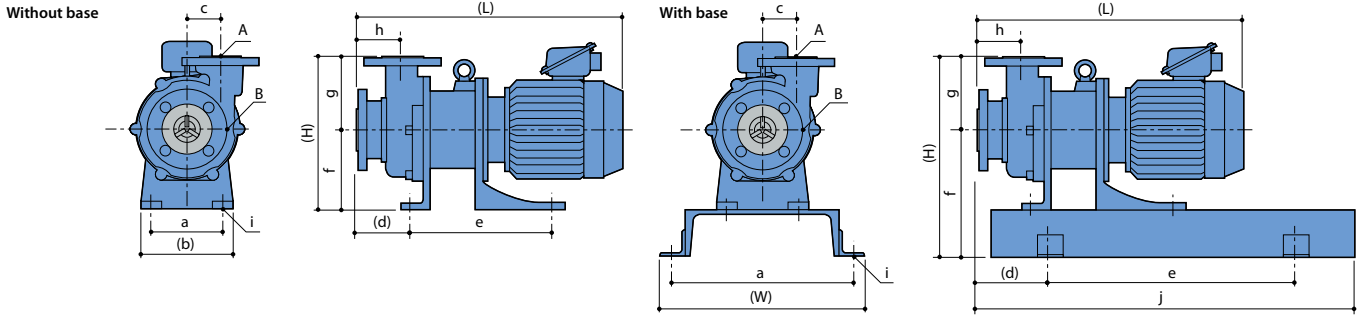

Model	(H)	(L)	A	B	a	(b)	c	(d)	e	f	g	h	i	
MXM220	237	453	25A	25A	110	150	51	95	143	115	122	88	4-ø12	
MXM220-H		475							165					
MXM221		470							165					
MXM221-H		470							165					
MXM441	275	485	40A	40A	130	170	58	113	250	135	140	106	4-ø14	
MXM441-H		498												250
MXM442		535												250
MXM442-H		535												250
MXM542	295	515	40A	50A	140	180	65	106	275	155	140	87	4-ø14	
MXM543		544												275
MXM545		589												275
MXM545		589												275

Model	(W)	(H)	(L)	A	B	a	c	d	e	f	g	h	i	j
MXM220	300	317	453	25A	25A	250	51	130	220	195	122	88	4-ø19	450
MXM220-H			475											
MXM221			470											
MXM221-H			470											
MXM441	350	365	485	40A	40A	300	58	130	260	225	140	106	4-ø19	489
MXM441-H			498											
MXM442			535											
MXM442-H			535											
MXM542	400	385	515	40A	50A	350	65	140	480	245	140	87	4-ø19	735
MXM543			544											
MXM545			589											
MXM545			589											

Optional accessories

Iwaki pump protector DRN series

Detects unusual pump operating conditions including dry-running and overload

The DRN model protects equipment (including pumps) from damage!
 Minimizes production downtime.
 Identifies possible causes of alarms so they can be investigated and addressed.



- Multiple Input: Two analog, one digital, one temperature input and one current input
- Easy operation: Equipped with EASY setup mode to remember the operation status and set the lower/upper limit values, as well as AUTO setup mode
- Bar graph: Visible indication of current operating status
- Logging capability: Data log feature for preventative maintenance scheduling
- Communication: RS485 external communication capability

Specifications

Model	DRN-01	DRN-02
Amperometric range	0.5-30.00A	5.0-200.0A
Unit's source voltage	AC100-240V 50/60Hz 10VA	
Operating temperature	0-40°C	
Operating humidity	35-85%RH	

IWAKI CO., LTD. 6-6 Kanda-Sudacho 2-chome Chiyoda-ku Tokyo 101-8558 Japan TEL : (81)3 3254 2935 FAX : 3 3252 8892 IWAKI has global net work. Please find your distributor location at www.iwakupumps.jp

European office : IWAKI Europe GmbH Germany : IWAKI Europe GmbH Holland : IWAKI Europe GmbH (Netherlands Branch) Italy : IWAKI Europe GmbH (Italy Branch) Spain : IWAKI Europe GmbH (Spain Branch) Belgium : IWAKI Belgium N.V. Denmark : IWAKI Nordic A/S Finland : IWAKI Suomi Oy France : IWAKI France S.A. Norway : IWAKI Norge AS Sweden : IWAKI Sverige AB U.K. : IWAKI Pumps (UK) Ltd.	TEL: (49)2154 9254 0 FAX: 2154 9254 48 TEL: (49)2154 9254 50 FAX: 2154 9254 55 TEL: (31)74 2420011 FAX: (49)2154 925448 TEL: (39)0444 371115 FAX: 0444 335350 TEL: (34)93 37 70 198 FAX: 93 47 40 991 TEL: (32)113 67 02 00 FAX: 13 67 20 30 TEL: (45)48 24 2345 TEL: (358)9 2745810 TEL: (33)1 69 63 33 70 FAX: 1 64 49 92 73 TEL: (47)23 38 49 00 TEL: (46)8 511 72900 TEL: (44)1743 231363 FAX: 1743 366507 () Country codes	U.S.A. : IWAKI America Inc. Argentina : IWAKI America Inc. (Argentina Branch) Brasil : IWAKI Do Brasil Comercio De Bombas Hidraulicas LTDA. Singapore : IWAKI Singapore Pte Ltd. Indonesia : IWAKI Singapore (Indonesia Office) Malaysia : IWAKI Sdn. Bhd. Australia : IWAKI Pumps Australia Pty Ltd. Hong Kong : IWAKI Pumps Co., Ltd. China : GFTZ IWAKI Engineering & Trading Co., Ltd. : IWAKI Pumps (Shanghai) Co., Ltd. Korea : IWAKI Korea Co., Ltd. Taiwan : IWAKI Pumps Taiwan Co., Ltd. Thailand : IWAKI (Thailand) Co., Ltd.	TEL: (1)508 429 1440 FAX: 508 429 1386 TEL: (54)11 4745 4116 TEL: (55)19 3244 5900 FAX: 19 3244 5900 TEL: (65)6316 2028 FAX: 6316 3221 TEL: (62)21 6906606 FAX: 21 6906612 TEL: (60)3 7803 8807 FAX: 3 7803 4800 TEL: (61)2 9899 2411 FAX: 2 9899 2421 TEL: (852)2607 1168 FAX: 2607 1000 TEL: (86)20 84350603 FAX: 20 84359181 TEL: (86)21 6272 7502 FAX: 21 6272 6929 TEL: (82)2 2630 4800 FAX: 2 2630 4801 TEL: (886)2 8227 6900 FAX: 2 8227 6818 TEL: (66)2 322 2471 FAX: 2 322 2477
--	--	---	--

Caution for safety use: Before use of pump, read instruction manual carefully to use the product correctly. Actual pumps may differ from the photos. Specifications and dimensions are subject to change without prior notice. For further details please contact us.

Legal attention related to export. Our products and/or parts of products fall in the category of goods contained in control list of international regime for export control. Please be reminded that export license could be required when products are exported due to export control regulations of countries. The posting and copying from this catalogue without permission is not accepted firmly.